

# Digital universal particle concentration sensor

## PMS3003 series data manual

Writer	Zhou Yong	Version	V2.3
Verifier	Zheng Haoxin	Date	2016-06-01



### Main characteristics

- ◆ Zero false alarm rate
- ◆ Real-time response
- ◆ Correct data
- ◆ Minimum distinguishable particle diameter :0.3 micrometer

### Overview

PMS3003 is a kind of digital and universal particle concentration sensor, which can be used to obtain the number of suspended particles in the air, i.e. the concentration of particles, and output them in the form of digital interface. This sensor can be inserted into variable instruments related to the concentration of suspended particles in the air or other environmental improvement equipments to provide correct concentration data in time.

## Working principle

Laser scattering principle is used for such sensor, i.e. produce scattering by using laser to radiate suspending particles in the air, then collect scattering light in a certain degree, and finally obtain the curve of scattering light change with time. In the end, equivalent particle diameter and the number of particles with different diameter per unit volume can be calculated by microprocessor based on MIE theory. Please find the functional diagram of each part of sensor from Figure 1 as follows.

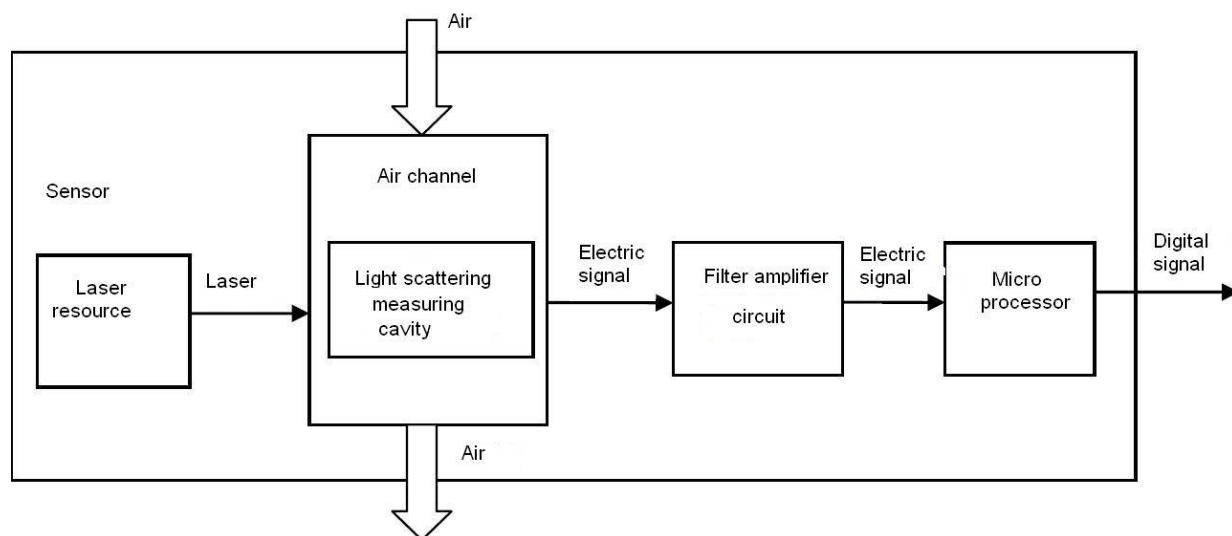

Figure 1 Functional block diagram of sensor

## Technical Index

Parameter	Index	unit
Range of measurement	0.3~1.0; 1.0~2.5; 2.5~10	Micrometer ( $\mu\text{ m}$ )
Counting Efficiency	50%@0.3 $\mu\text{ m}$ 98%@ $\geq 0.5\mu\text{ m}$	
Effective Range (PM2.5 standard)	0~500	$\mu\text{ g/m}^3$
Maximum Range (PM2.5 standard) *	$\geq 1000$	$\mu\text{ g/m}^3$
Resolution	1	$\mu\text{ g/m}^3$

Maximum Consistency Error (PM2.5 standard data)*	$\pm 10\% @ 100 \sim 500 \mu \text{g}/\text{m}^3$ $\pm 10 \mu \text{g}/\text{m}^3 @ 0 \sim 100 \mu \text{g}/\text{m}^3$	
Standard Volume	0.1	Litre (L)
Single Response Time	<1	Second (s)
Total Response Time	$\leq 10$	Second (s)
DC Power Supply	Typ:5.0 Min:4.5 Max: 5.5	Volt (V)
Active Current	$\leq 100$	Milliampere (mA)
Standby Current	$\leq 200$	Microampere ( $\mu \text{A}$ )
Interface Level	L < 0.8 @ 3.3 H > 2.7 @ 3.3	Volt (V)
Working Temperature Range	-10~+60	$^{\circ}\text{C}$
Working Humidity Range	0~99%	
Storage Temperature Range	-40~+80	$^{\circ}\text{C}$
MTTF	$\geq 3$	Year (Y)
Physical Size	50×43×21	Millimeter (mm)

Note 1: Maximum range means that the highest output value of the PM2.5 standard data is not less than 1000.

Note 2: "PM2.5 standard data" is the "data2" in the appendix.

## Pin Definition



Figure 2 Connector Definition

<b>PIN1</b>	VCC	Positive power 5V
<b>PIN2</b>	GND	Negative power
<b>PIN3</b>	SET	Set pin /TTL level @3.3V, high level or suspending is normal working status, while low level is sleeping mode.
<b>PIN4</b>	RX	Serial port receiving pin/TTL level@3.3V
<b>PIN5</b>	TX	Serial port sending pin/TTL level@3.3V
<b>PIN6</b>	RESET	Module reset signal /TTL level@3.3V, low reset.
<b>PIN7/8</b>	NC	

## Output result

Mainly output is mass concentration and the unit is  $\mu\text{g}/\text{m}^3$ .

There are two options for digital output: passive and active. Default mode is active after power up. In this mode sensor would send serial data to the host automatically. The active mode is divided into two sub-modes: stable mode and fast mode. If the concentration change is small the sensor would run at stable mode with the real interval of 2.3s. And if the change is big the sensor would be changed to fast mode automatically with the interval of 200~800ms, the higher of the concentration, the shorter of the interval.

## Typical Circuit

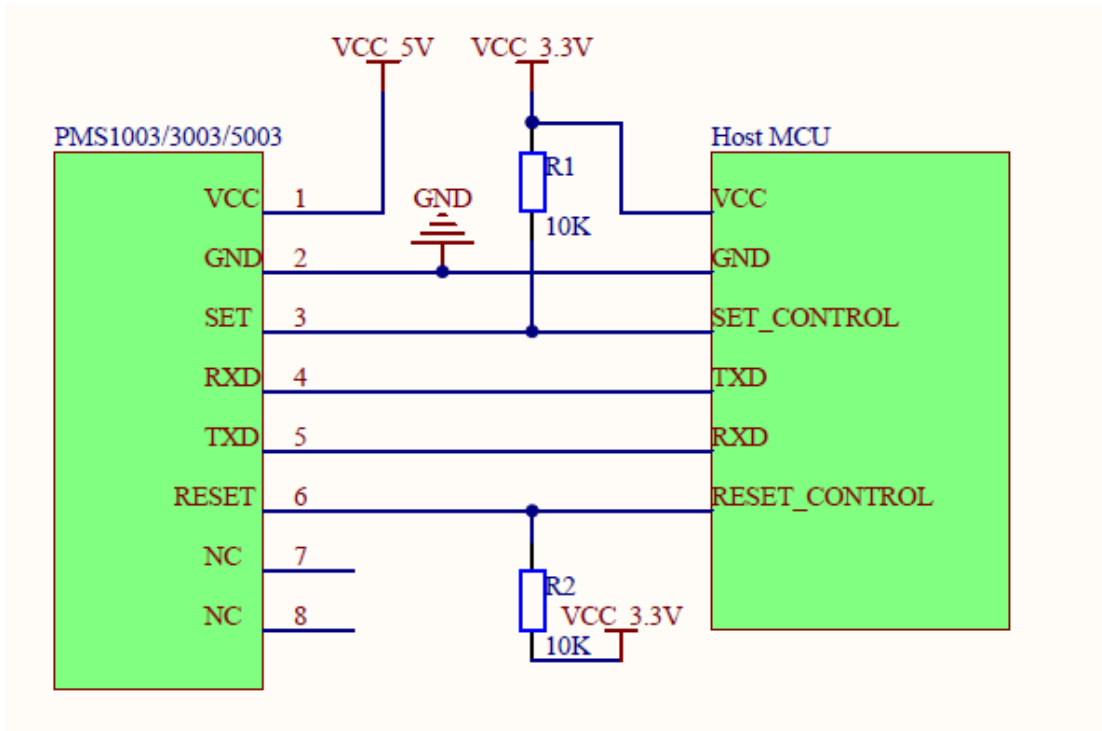

Figure 3 Typical Circuit

## Typical Output Characteristic

Definition of axis Y: PM2.5 concentration , unit:  $\mu\text{g}/\text{m}^3$

Definition of axis X: number of samples, unit: time

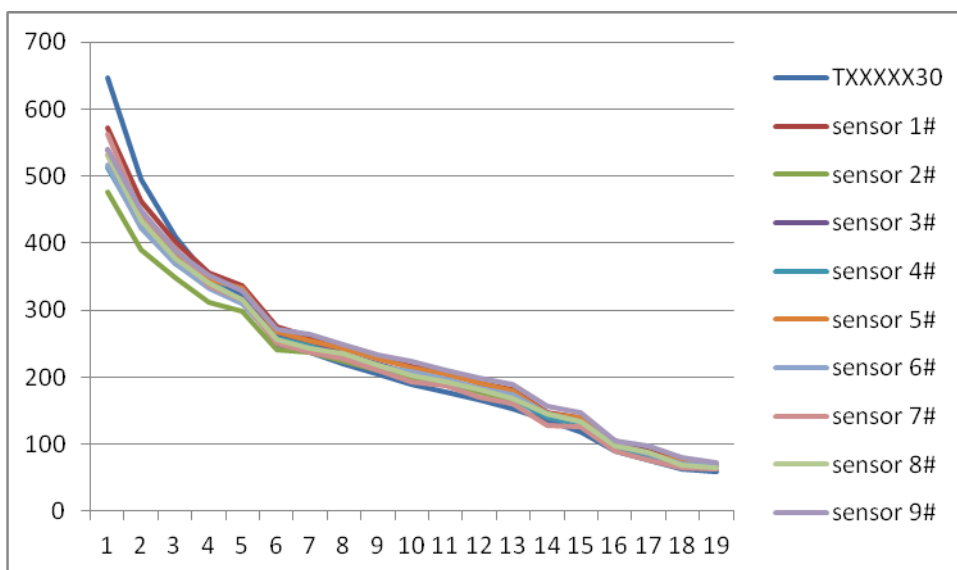

Figure 4-1 Consistency at 20°C

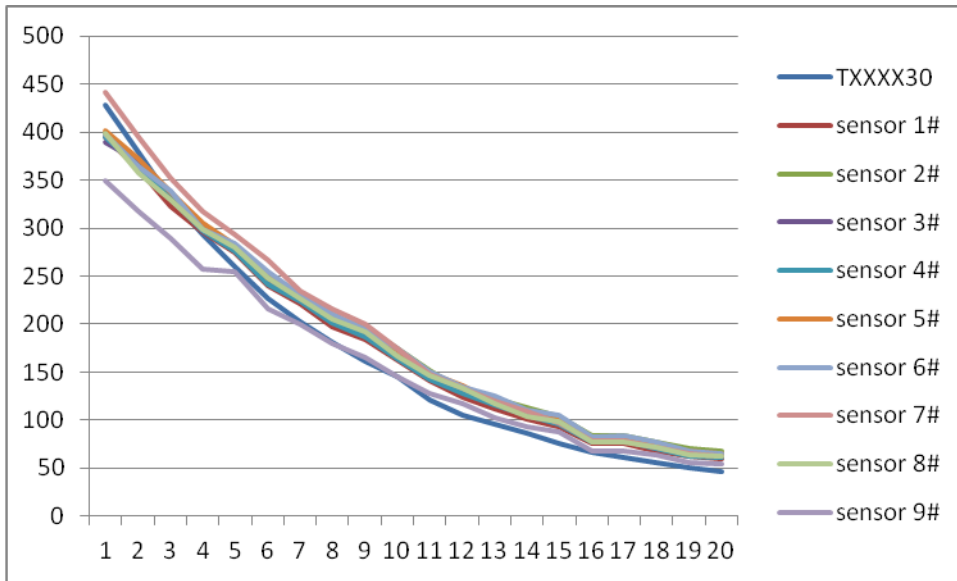

Figure 4-2 Consistency at 43°C

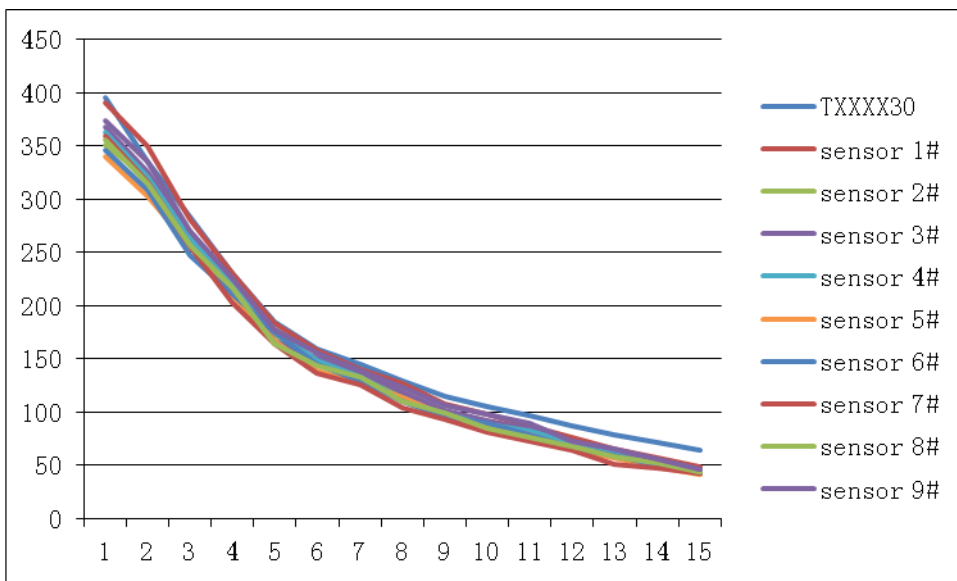

Figure 4-3 Consistency at -5°C

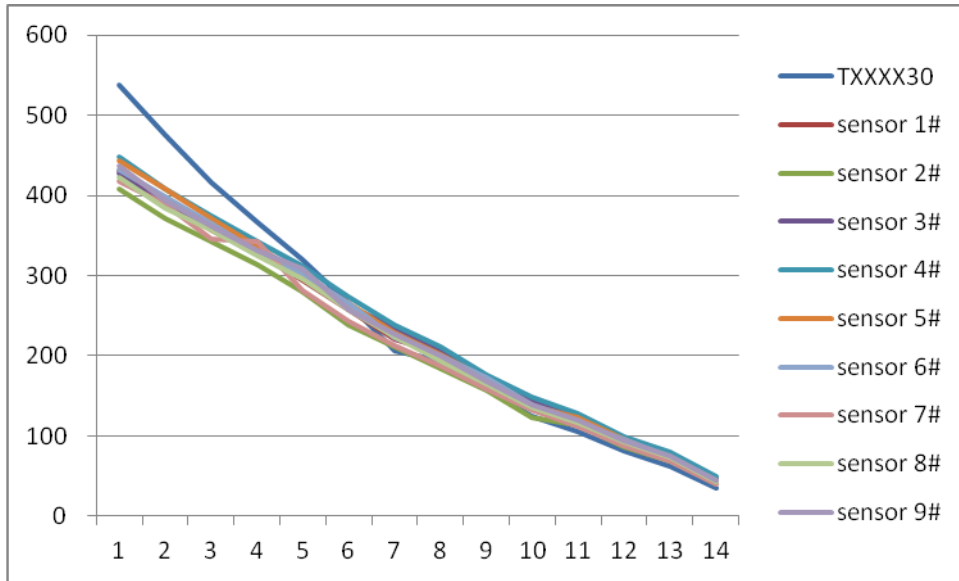

Figure 4-4 Consistency after 30 days' running

### Relationship of Temperature and Consistency

Definition of axis Y: Maximum Error Modulus(%)

Definition of axis X: Temperature(°C)

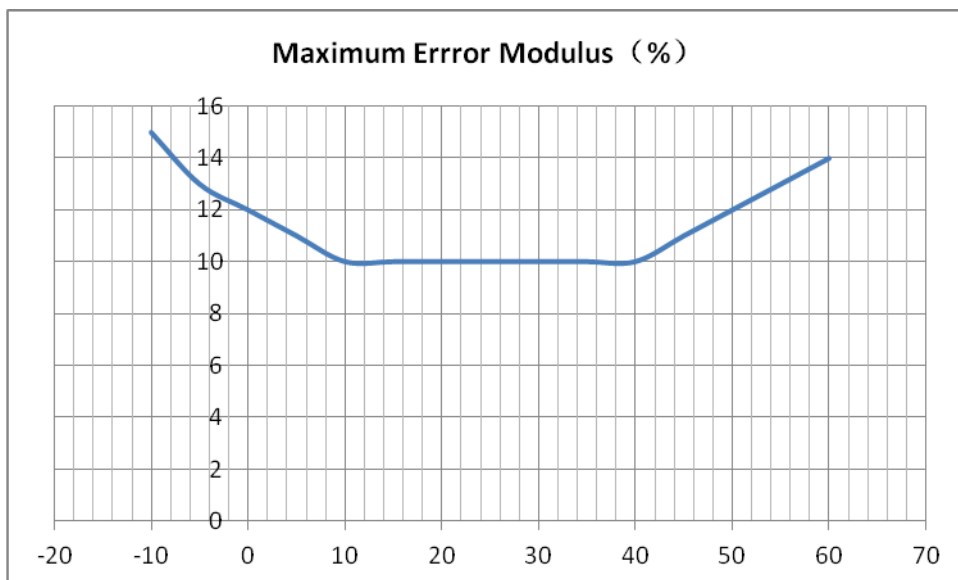

Figure 5 Consistency Vs Temperature

## Endurance Characteristics

No	Item	Test Method	Characteristics	n C
1	Long Running	<ol style="list-style-type: none"> <li>10 m<sup>2</sup> closed Lab,, 20~25℃, humidity 30%~70%, particle generator and air cleaner</li> <li>DC 5V power supply</li> <li>Check consistency after 720 hours' running</li> </ol>	10 samples during 0~500μ g/m <sup>3</sup>  0~100μ g/m <sup>3</sup> Maximum Error ≤ ± 15μ g/m <sup>3</sup>	n=30 C=0
2	High Temperature Operation	<ol style="list-style-type: none"> <li>10 m<sup>2</sup> constant temperature Lab</li> <li>43℃, humidity 70%,</li> <li>particle generator and air cleaner</li> <li>DC 5V power supply</li> <li>Check consistency</li> </ol>	100~500μ g/m <sup>3</sup> Maximum Error ≤ ± 15%	n=10 C=0
3	Cold Operation	<ol style="list-style-type: none"> <li>10 m<sup>2</sup> constant temperature Lab</li> <li>-5℃, humidity 30%,</li> <li>particle generator and air cleaner</li> <li>DC 5V power supply</li> <li>Check consistency</li> </ol>	FAN does not screeched	n=10 C=0
4	Vibration	<ol style="list-style-type: none"> <li>10 m<sup>2</sup> closed Lab,, 20℃, humidity 50%, particle generator and air cleaner</li> <li>DC 5V power supply and check consistency</li> <li>Frequency: 50Hz。</li> <li>acceleration: 9.8/ S<sup>2</sup>。</li> <li>Direction: X、 Y、 Z</li> <li>Vibration Amplitude: ±2mm。</li> <li>Time: X、 Y、 Z –way, Per 1 hour</li> </ol>		n=5 C=0
5	High Temperature and Humidity Storage	<ol style="list-style-type: none"> <li>Constant temperature cabinet</li> <li>70℃, humidity 90%~95,</li> <li>Check consistency after 500 hours' storage</li> </ol>	10 samples during 0~500μ g/m <sup>3</sup>  0~100μ g/m <sup>3</sup> Maximum Error ≤ ± 10μ g/m <sup>3</sup>	n=10 C=0
6	Cold Storage	<ol style="list-style-type: none"> <li>Constant temperature cabinet</li> <li>-30℃, humidity 90%~95,</li> <li>Check consistency after 500 hours' storage</li> </ol>	100~500μ g/m <sup>3</sup> Maximum Error ≤ ± 10%	n=10 C=0
7	Variation of	<ol style="list-style-type: none"> <li>10 m<sup>2</sup> closed Lab,, 20℃, humidity</li> </ol>		n=5



	Power Supply	50%, particle generator and air cleaner  5. Power varies as the cycles of 4.5V to 5.5V ,then 5.5V to 4.5V with the pace of 0.1V/min for 2 hours. 6. Check consistency during Variation	FAN does not screeched	C=0
8	Power On-Off Cycle	1. 10 m <sup>2</sup> closed Lab,, 20°C , humidity 50%, particle generator and air cleaner 2. DC 5V power supply, keep On-Off frequency 0.5Hz for 72 hours and check consistency		n=10 C=0
9	Sleep Set On-Off Cycle	1. 10 m <sup>2</sup> closed Lab,, 20°C , humidity 50%, particle generator and air cleaner 2. DC 5V power supply, keep Sleep Set Pin High-Low frequency 0.5Hz for 72 hours and check consistency		n=10 C=0
10	Laser On-Off Cycle	1. 10 m <sup>2</sup> closed Lab,, 20°C , humidity 50%, particle generator and air cleaner 2. keep laser On-Off frequency 50Hz for 240 hours and check consistency		n=10 C=0
11	Salt Spray	5% industrial salt water, hydrolysis spray 100 hours, clean with purified water and store for 48 hours	No rust and discoloration of metal parts	n=1 C=0

## Circuit Attentions

- 1) DC 5V power supply is needed because the FAN should be driven by 5V. But the high level of data pin is 3.3V. Level conversion unit should be used if the power of host MCU is 5V.
- 2) The SET and RESET pins are pulled up inside so they should not be connected if without usage.
- 3) PIN7 and PIN8 should not be connected.
- 4) Stable data should be got at least 30 seconds after the sensor wakeup from the sleep mode because of the fan's performance.

## Installation Attentions

- 1) Metal shell is connected to the GND so be careful not to let it shorted with the other parts of circuit except GND.
- 2) The best way of install is making the plane of inset closely to the plane of the host. Or some shield should be placed between inset and outset in order to prevent the air flow from inner loop.
- 3) The blowhole in the shell of the host should not be smaller than the inset.
- 4) The sensor should not be installed in the air flow way of the air cleaner or should be shielded by some structure.
- 5) The sensor should be installed at least 20cm higher than the grand in order to prevent it from blocking by the floc dust.
- 6) Do not break up the sensor.

## Other Attentions

- 1) Only the consistency of all the PM sensors of PLANTOWER is promised and ensured. And the sensor should not be checked with any third party equipment.
- 2) The sensor is usually used in the common indoor environment. So some protection must be added if using in the conditions as followed:
  - a) The time of concentration  $\geq 300\mu\text{ g/m}^3$  is longer than 50% of the whole year or concentration  $\geq 500\mu\text{ g/m}^3$  is longer than 20% of the whole year.
  - b) Kitchen
  - c) Water mist condition such as bathroom or hot spring.
  - d) outdoor

## Part Number Definition

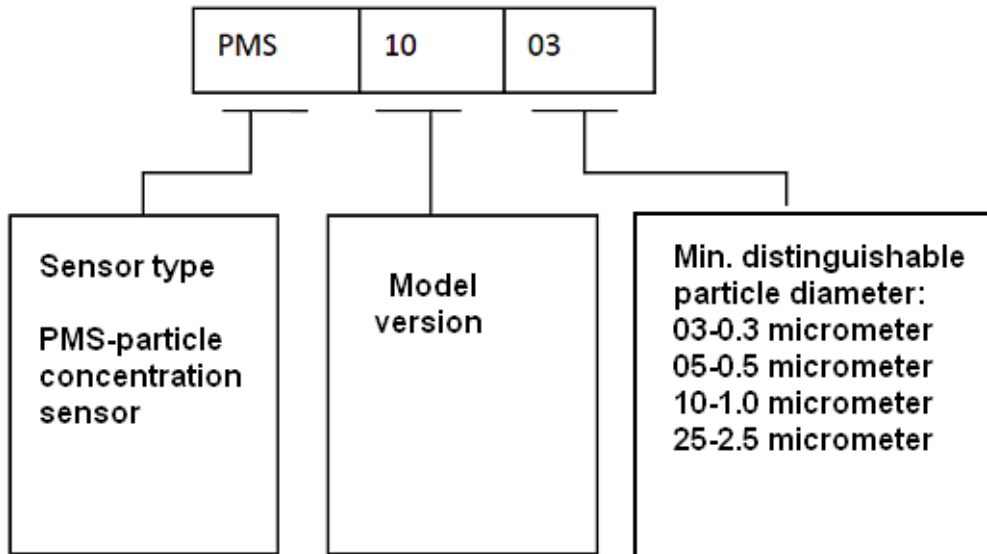

### Physical Size(mm)

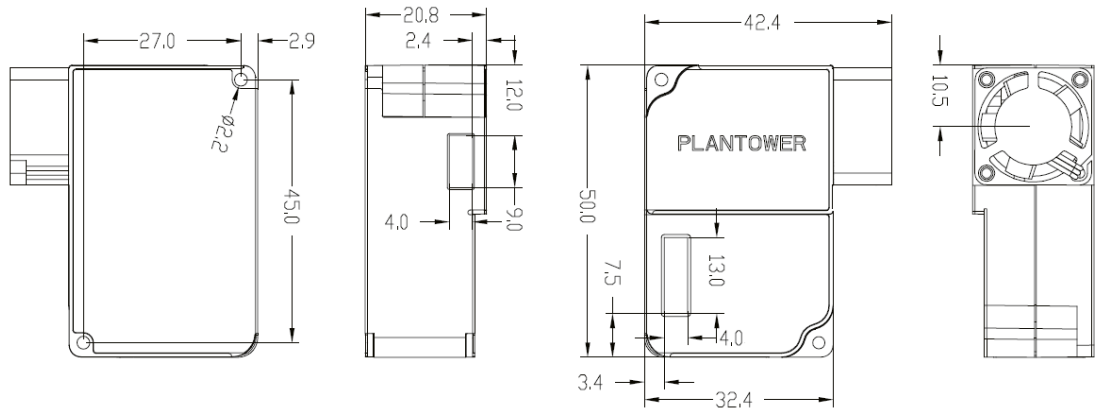

## Appendix I: PMS3003 transport protocol-Active Mode

Default baud rate: 9600bps Check bit: None Stop bit: 1 bit

24 Bytes

Start character 1	0x42	(Fixed)
Start character2	0x4d	(Fixed)
Frame length high 8 bits	.....	Frame length=2x13+2(data+check bytes)
Frame length low 8 bits	.....	
Data 1 high 8 bits	.....	Data1 refers to PM1.0 concentration unit $\mu$ g/m <sup>3</sup> (CF=1, standard particle)
Data 1 low 8 bits	.....	
Data2 high 8 bits	.....	Data2 refers to PM2.5 concentration unit $\mu$ g/m <sup>3</sup> (CF=1, standard particle)
Data2 low 8 bits	.....	
Data3 high 8 bits	.....	Data3 refers to PM10 concentration unit $\mu$ g/m <sup>3</sup> (CF=1, standard particle)
Data3 low 8 bits	.....	
Data4 high 8 bits	.....	Data4 refers to PM1.0 concentration unit $\mu$ g/m <sup>3</sup> (under atmospheric environment)
Data4 low 8 bits	.....	
Data5 high 8 bits	.....	Data 5 refers to PM2.5 concentration unit $\mu$ g/m <sup>3</sup> (under atmospheric environment)
Data5 low 8 bits	.....	
Data6 high 8 bits	.....	Data 6 refers to concentration unit (under atmospheric environment) $\mu$ g/m <sup>3</sup>
Data6 low 8 bits	.....	
Data7 high 8 bits	.....	reserved
Data7 low 8 bits	.....	
Data8 high 8 bits	.....	reserved
Data8 low 8 bits	.....	
Data9 high 8 bits	.....	reserved
Data9 low 8 bits	.....	

---

Data and check high 8 bits	.....	Check code=Start character 1+ Start character 2+.....+data 13 Low 8 bits
Data and check low 8 bits	.....	

Note: CF=1 should be used in the factory environment

## Appendix II: PMS3003 transport protocol-Passive Mode

Default baud rate: 9600bps Check bit: None Stop bit: 1 bit

### Host Protocol

Start Byte 1	Start Byte 2	Command	Data 1	Data 2	Verify Byte 1	Verify Byte 2
0x42	0x4d	CMD	DATAH	DATAL	LRCH	LRCL

#### 1. Command Definition

CMD	DATAH	DATAL	说明
0xe2	X	X	Read in passive mode
0xe1	X	00H-passive 01H-active	Change mode
0xe4	X	00H-sleep 01H-wakeup	Sleep set

#### 2. Answer

0xe2: 32 bytes , same as appendix I

#### 3. Verify Bytes :

Add of all the bytes except verify bytes.